

D Series

Miniature Snap-in Power Rocker Switches



Description

The D series are miniature snap-in power rocker switches that are commonly used by designers of small appliance, computer and peripheral or medical instrumentation products. The D series switches feature both momentary and maintained models, PC and quick connect terminals – and have an available recessed bracket, helping to prevent accidental actuation.

Features & Benefits

- Momentary and maintained models
- PC and quick connect terminals
- Recessed bracket available — prevents accidental actuation
- RoHS compliant
- Gold plated options available

Applications

- Small appliances
- Computers and peripherals
- Medical instrumentation

Agency Approvals

Agency	Agency File Number
	E61760

Contact Rating

Part Number	GP (general purpose)	R (resistive)
D101	4 amps 125 VAC 50/60 Hz T85 10,000 cycles 2 amps 250 VAC 50/60 Hz T85 10,000	4 amps 30 VDC T85 10,000 cycles
D501, D502, D602	10 amps 125 VAC 50/60 Hz T85 10,000 cycles 5 amps 250 VAC 50/60 Hz T85 10,000	10 amps 30 VDC T85 10,000 cycles

Notes:
0.4VA @ 20V AC/DC (gold plating) available upon request

Specifications

Electrical Life	10,000 make-and-break cycles at full load.
Dielectric Strength	1,000 Vrms min. @ sea level.
Insulation Resistance	10 ⁹ Ω min.

Materials

Actuator & Housing	6/6 nylon (UI 94V-2) color black, finish: matte.
Movable Contacts	D10X and D20X Models: Copper, silver plated. D50X and D60X Models: Coin silver, silver plated.
Stationary Contacts and Terminals	Copper or brass, silver plated
Contact Spring	Music wire or stainless steel.
Operating Temperature	-30°C to 65°C

Notes:
Specifications and materials listed above are for standard switches. For information on specific and custom switches, consult Customer Service Center.

D Series

Miniature Snap-in Power Rocker Switches



Ordering Number

To order, simply select desired option from each category and place in the appropriate box. For additional options not shown in catalog, consult Customer Service Center.

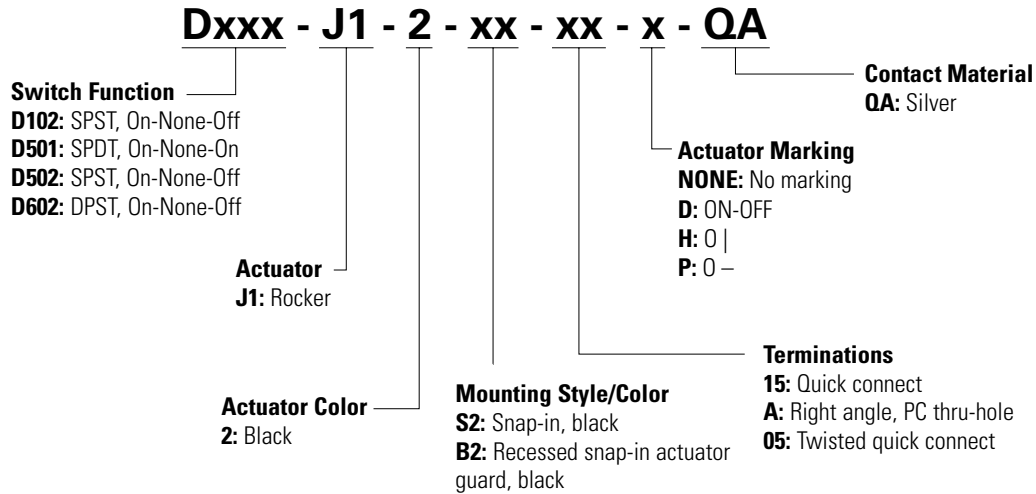

Switch Function

SPDT

No. Poles	Model No.	Amp Rating ¹	Switch Function			Connected Terminals			Schematic
			C&K marking on opposite side						
			POS.1	POS.2	POS.3	POS.1	POS.2	POS.3	
SP	D102 D502	4 10	ON	NONE	OFF	1-1A	N/A	OPEN	
	D501	4 10	ON	NONE	ON	1-1A	N/A	1-1B	

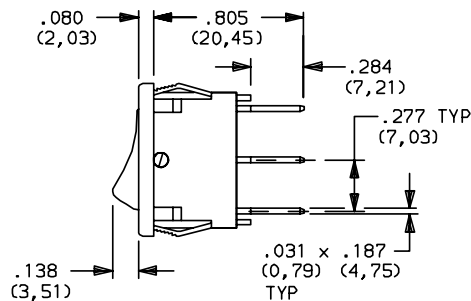

ACTUATOR SHOWN IN POSITION 1

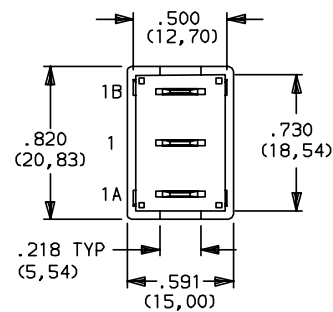

TERMINAL NOS.
FOR REF. ONLY

Part number shown: D101J12S215QA

D Series

Miniature Snap-in Power Rocker Switches



DPDT

No. Poles	Model No.	Amp Rating ¹	Switch Function			Connected Terminals			Schematic
			C&K marking on opposite side						
			POS.1	POS.2	POS.3	POS.1	POS.2	POS.3	
DP	D602	4 10	ON	NONE	OFF	1-1A, 2-2A	N/A	OPEN	

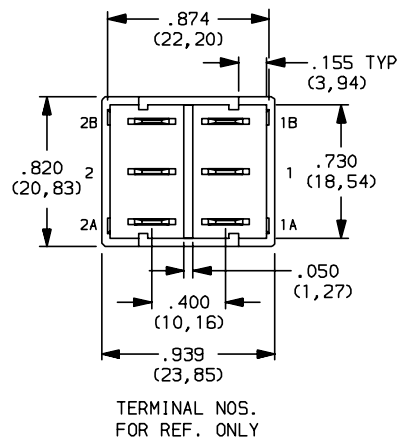
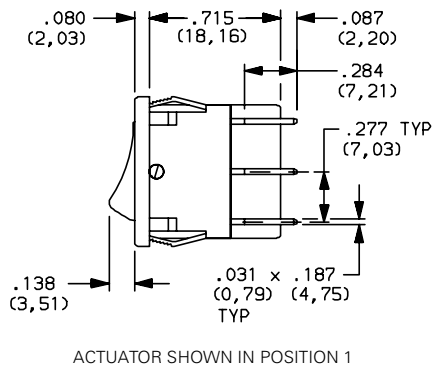

Notes: MOM. = Momentary us
 1. AMP RATING: see page 1 See CONTACT MATERIALS, page 5.

Actuator and Actuator Color

J1 Rocker SP

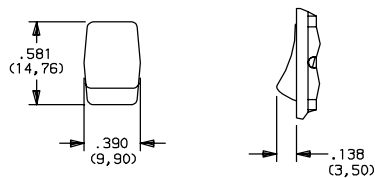

DP

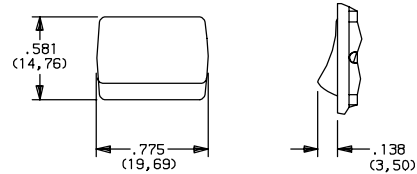

Actuator

Option Code	Actuator Color
2	Black

Note: Actuator finish: matte. Other colors available, consult Customer Service Center.

D Series

Miniature Snap-in Power Rocker Switches



Mounting Style/Color

S2 Snap-in, Black

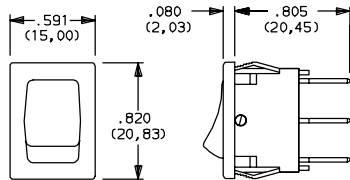

Note: Frame finish on housing: matte. Other colors available, consult Customer Service Center.

B2 Recessed Snap-in Actuator Guard, Black

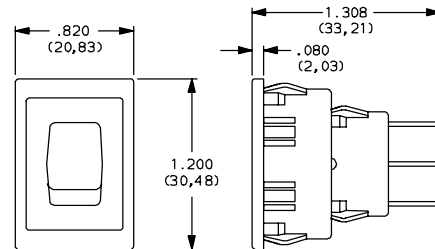

Note: Vertical mount, SP models only.

Panel Mounting

Panel Thickness	DIM 'A' SP & DP Models 'S' Mounting Style	DIM 'A' With 'G2' Option SP Models Only	DIM 'A' SP Models 'B' Mounting Style
0.030–0.049 (0.76) (1.24)	0.756 (19.20)	0.764 (19.41)	1.068 (27.13)
0.049–0.079 (1.24) (2.01)	0.764 (19.41)	0.780 (19.81)	1.076 (27.33)
0.079–0.118 (2.01) (3.00)	0.780 (19.81)	N/A	1.092 (27.74)

Panel Mounting

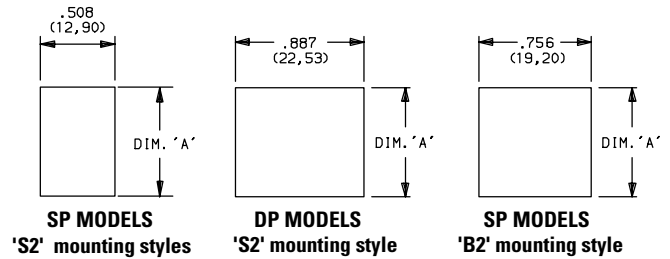

Note: Blank insert available for SP models only.

D Series

Miniature Snap-in Power Rocker Switches



Terminations

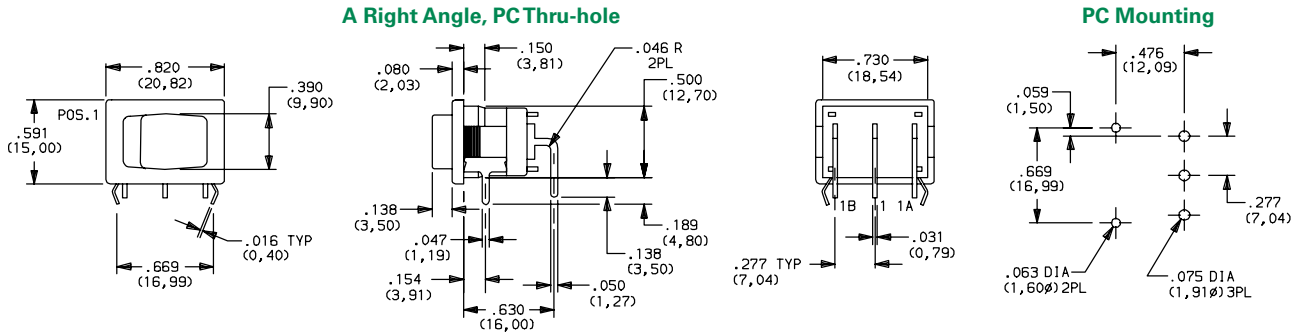

Available with D102, D501, D502 SP models only.

15 Quick Connect

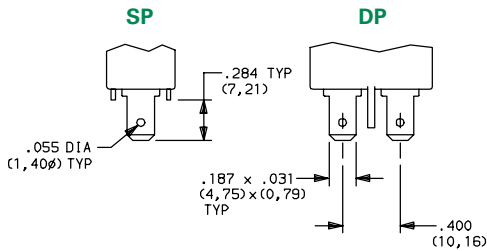

Available with DX01 and DX02 models only.

05 Twisted Quick Connect

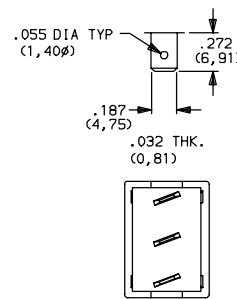

Note: Terminals are twisted.

Actuators



Notes: D, H and P marking options: marking color white, standard for all actuator colors except white. Black marking color, standard for white actuators. Consult Customer Service Center for other available marking colors.

Contact Material

Option Code	Contact and Terminal Material	Ratings
QA	Silver ¹	D102, GP (general purpose) 4 amps 125 VAC 50/60 Hz T85 10,000 cycles, 2 amps 250 VAC 50/60 Hz T85 10,000 cycles R (resistive), 4 amps 30 VDC T85 10,000 cycles, D501, D502, D602, GP (general purpose) 10 amps 125 VAC 50/60 Hz T85 10,000 cycles, 5 amps 250 VAC 50/60 Hz T85 10,000 cycles R (resistive) 10 amps 30 VDC T85 10,000 cycles

Notes:
1. Movable Contact: D10X and D20X Models: Copper, silver plated. D50X and D60X Models: Coin silver, silver plated.
2. Stationary Contacts & Terminals: Copper or brass, silver plated.

0.4VA @ 20V AC/DC Gold plated options available contact Customer Service. US

D Series

Miniature Snap-in Power Rocker Switches



Available Hardware

Insert SP Only

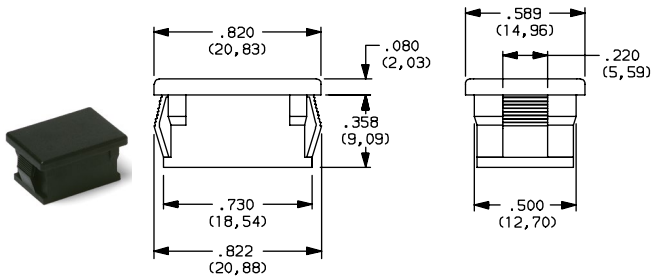

Part No. 057190200 Black
 Material: Nylon 6/6
 Finish: Matte

Recessed Actuator Guard, SP Only



Part No. 599D02000 Black
 Material: 6/6 Nylon
 Finish: Matte

Actuator Guard

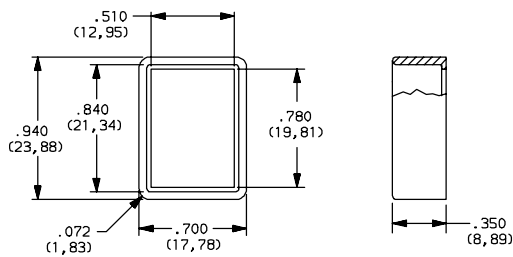

Part No. 104C22000
 Material: PBT thermoplastic
 Finish: Matte

Boot

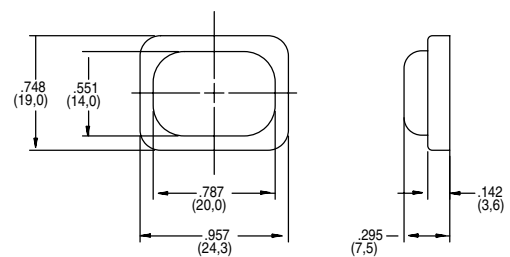

Part No. 216C00000
 IP54 Splash Proof Rubber Boot

Disclaimer Notice - Information furnished is believed to be accurate and reliable. However, users should independently evaluate the suitability of and test each product selected for their own applications. Littelfuse products are not designed for, and may not be used in, all applications. Read complete Disclaimer Notice at <http://www.littelfuse.com/disclaimer-electronics>.